

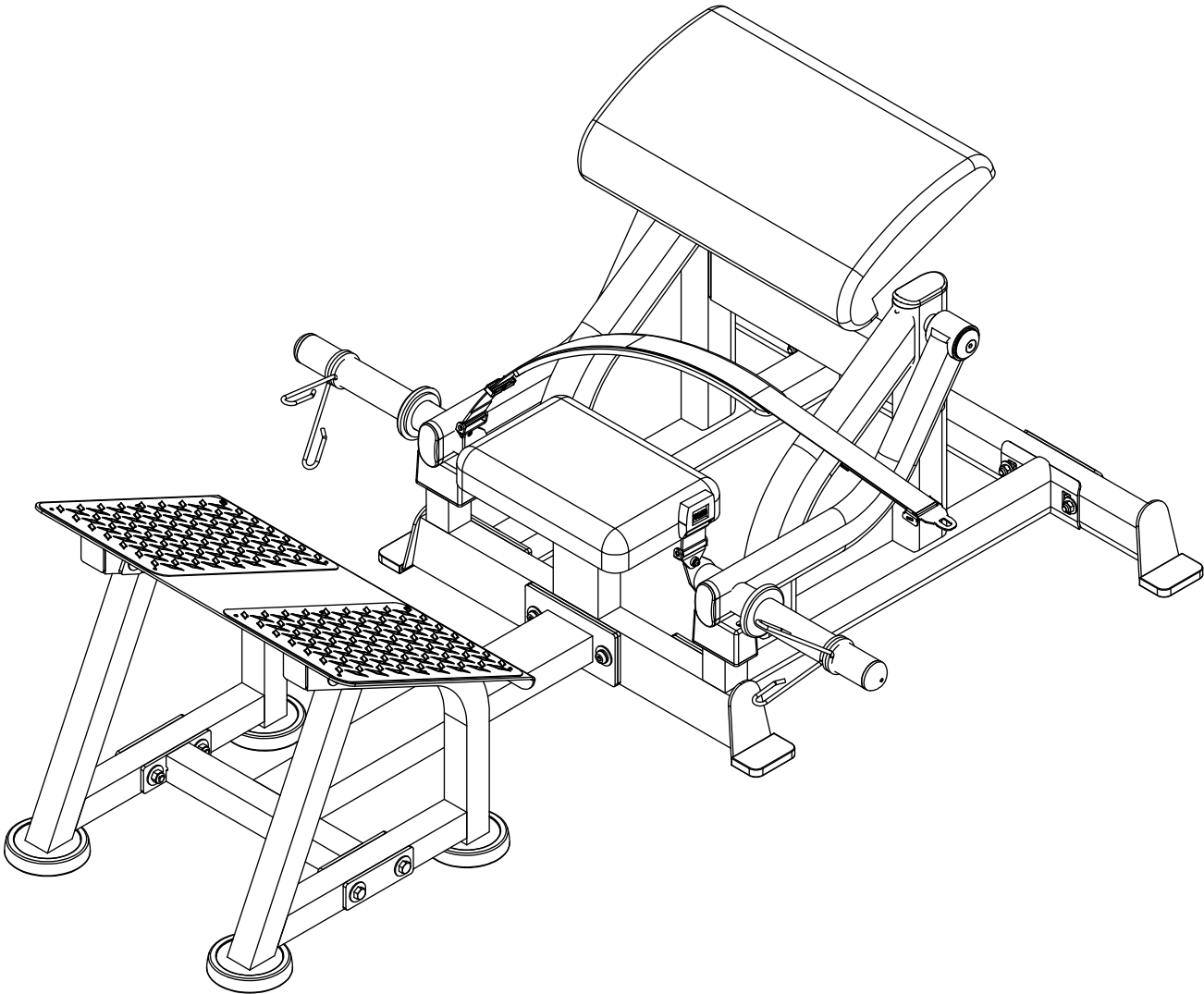

PLHT-BR



Assembly & Instructions
OWNER'S & MANUAL

PLHT-BR HARDWARE

(shown in actual size)

A1. M5x12L HEXAGON SOCKET HEAD SCREW...2PCS



A2. M8x25L HEXAGON SOCKET HEAD SCREW...8PCS



A3. M10x25L TAPER SOCKET HEAD SCREW...2PCS



A4. M10x65L GENERAL HEX HEAD SCREW...4PCS

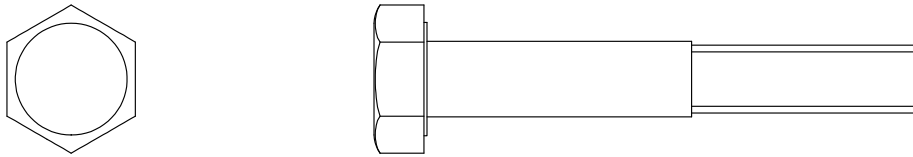

A5. M10x75L GENERAL HEX HEAD SCREW...4PCS

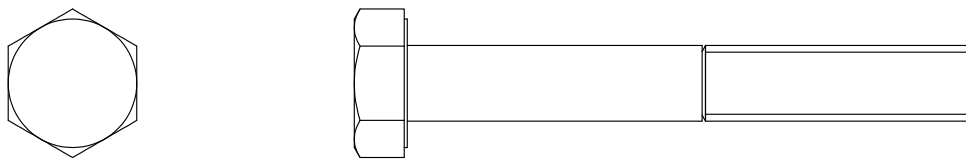

A6. M12x25L HEXAGON SOCKET HEAD SCREW...6PCS

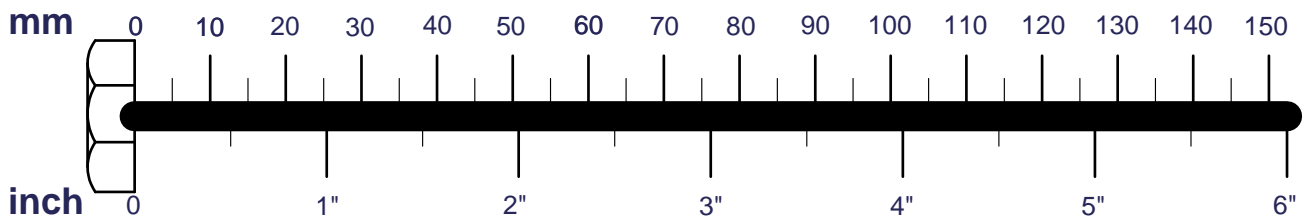

PLHT-BR HARDWARE

(shown in actual size)

A7. M12x80L GENERAL HEX HEAD SCREW...4PCS

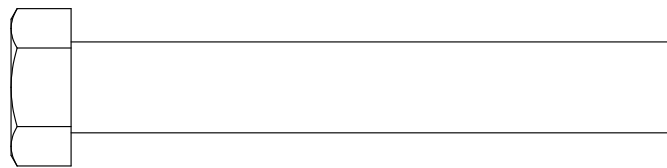
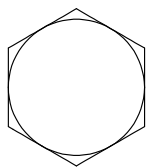

A8. M12x75L GENERAL HEX HEAD SCREW...4PCS

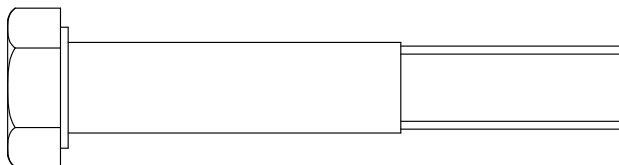
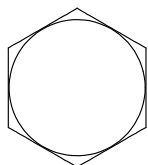

A9. M8x55L HEXAGON WITH ROUND HEAD CAP-SCREW...4PCS

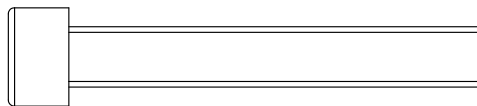
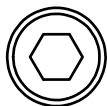

A10. M4x8L CHAU BLIND RIVET (Pre-installed) ...12PCS



B1. M10 NUT...4PCS

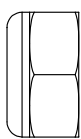
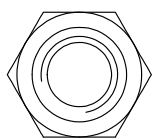

B2. M12 NUT...8PCS

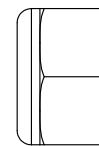
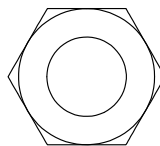

C1. M8 SPRING WASHER...12PCS



C2. M8 WASHER (Ø22) ...8PCS

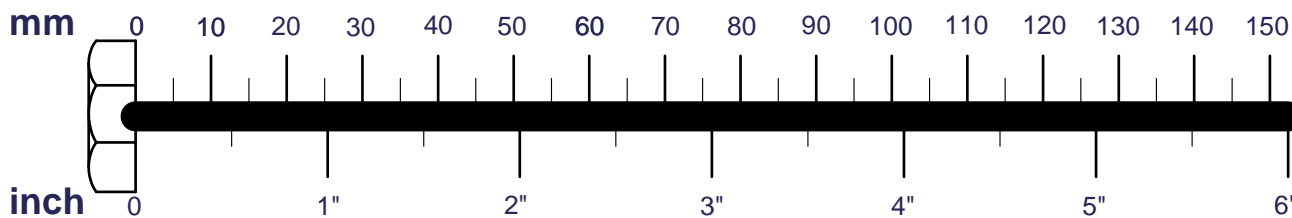
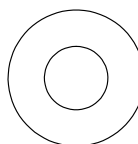

PLHT-BR HARDWARE

C3. M10 SPRING WASHER...2PCS

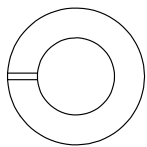

C4. M10 WASHER(Ø28)...12PCS

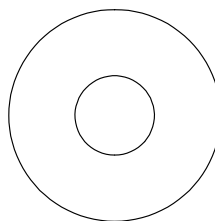

C5. M12 SPRING WASHER...6PCS

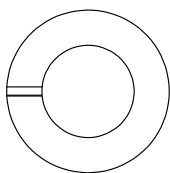

C6. M12 WASHER (Ø24) ...22PCS

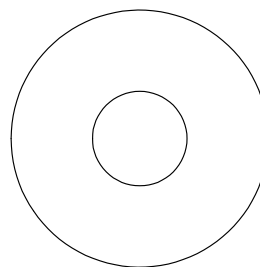

C7. M5 SPRING WASHER...2PCS



C8. M5 WASHER(Ø18)...2PCS

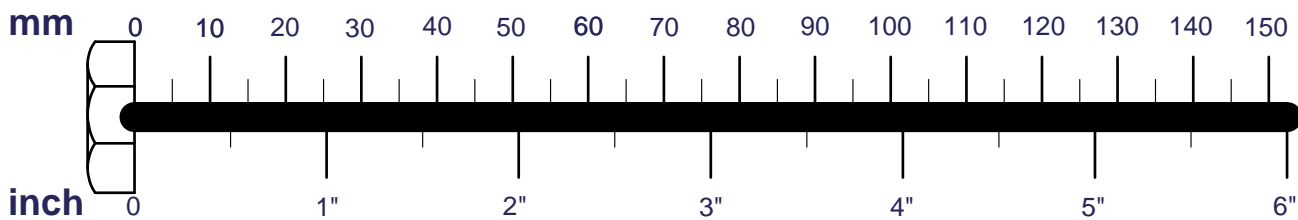

PLHT-BR PARTS

A [1PCS]

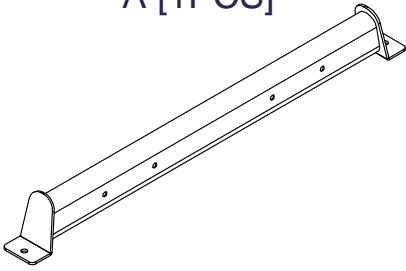

B [1PCS]

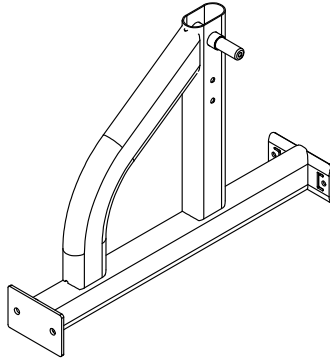

C [1PCS]

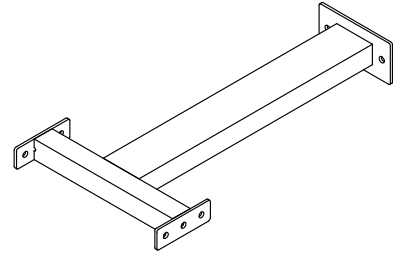

D [1PCS]

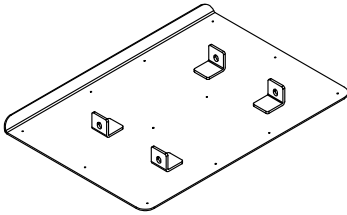

E [2PCS]

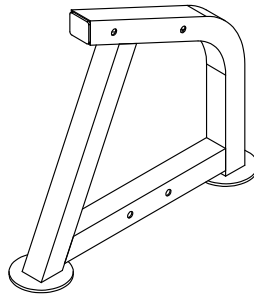

F [1PCS]

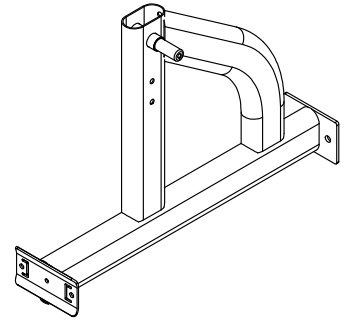

I [1PCS]

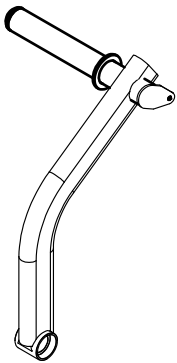

J [1PCS]

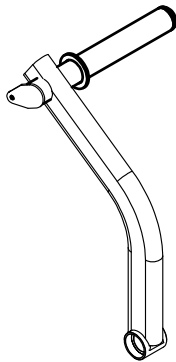

K [1PCS]

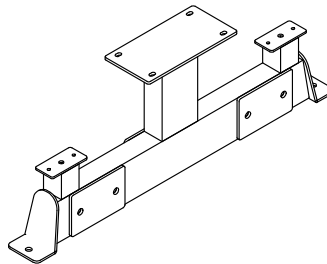

L [1PCS]

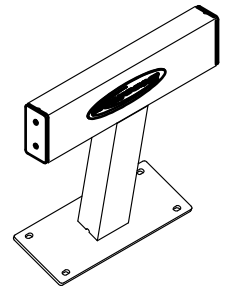

O [2PCS]
(8370-079)

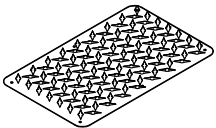

P [1PCS]
(9131-076)

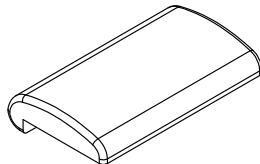

Q [1PCS]
(9121-126)

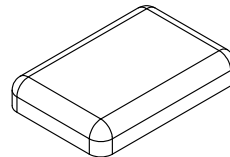

R [2PCS]
(8312-062)

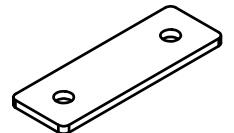

S [2PCS]
(8312-049)

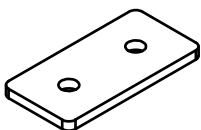

U [2PCS]
(8323-150)

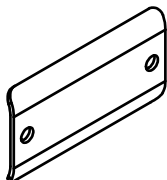

M [1PCS]
(9630-331)

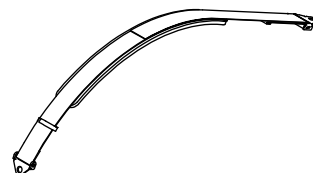

N [1PCS]
(9630-330)

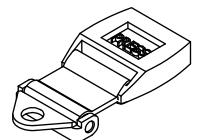

PLHT-BR PARTS

D1.Rubber Pad (9310-134)	4PCS
D5.Door mat(9310-136)	4PCS
D6.Rubber block(9310-077)	2PCS
D7.Elliptical Plug(9211-193)	2PCS
D8.Elliptical Plug (9211-192)	2PCS
D9.Rubber Ring (9310-016)	2PCS
D10. Pinch Cock (OC-06).....	2PCS
D13. Bearing(8510-037)(Pre-installed)	4PCS
D14.End Cover (8130-131).....	2PCS
D16.Protective Cover(8110-171).....	2PCS

D1

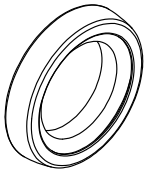

D5

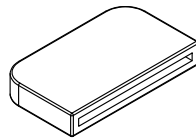

D6

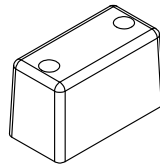

D7

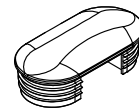

D8

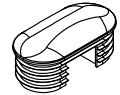

D9

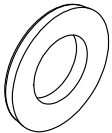

D10

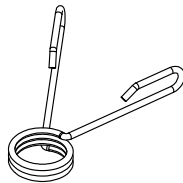

D13

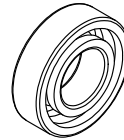

D14



D16

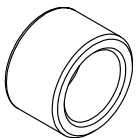

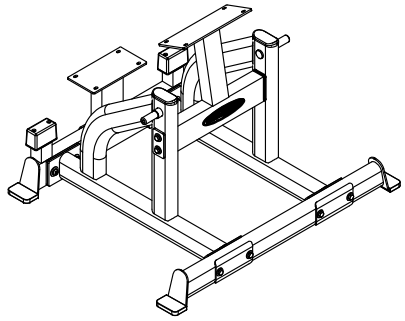



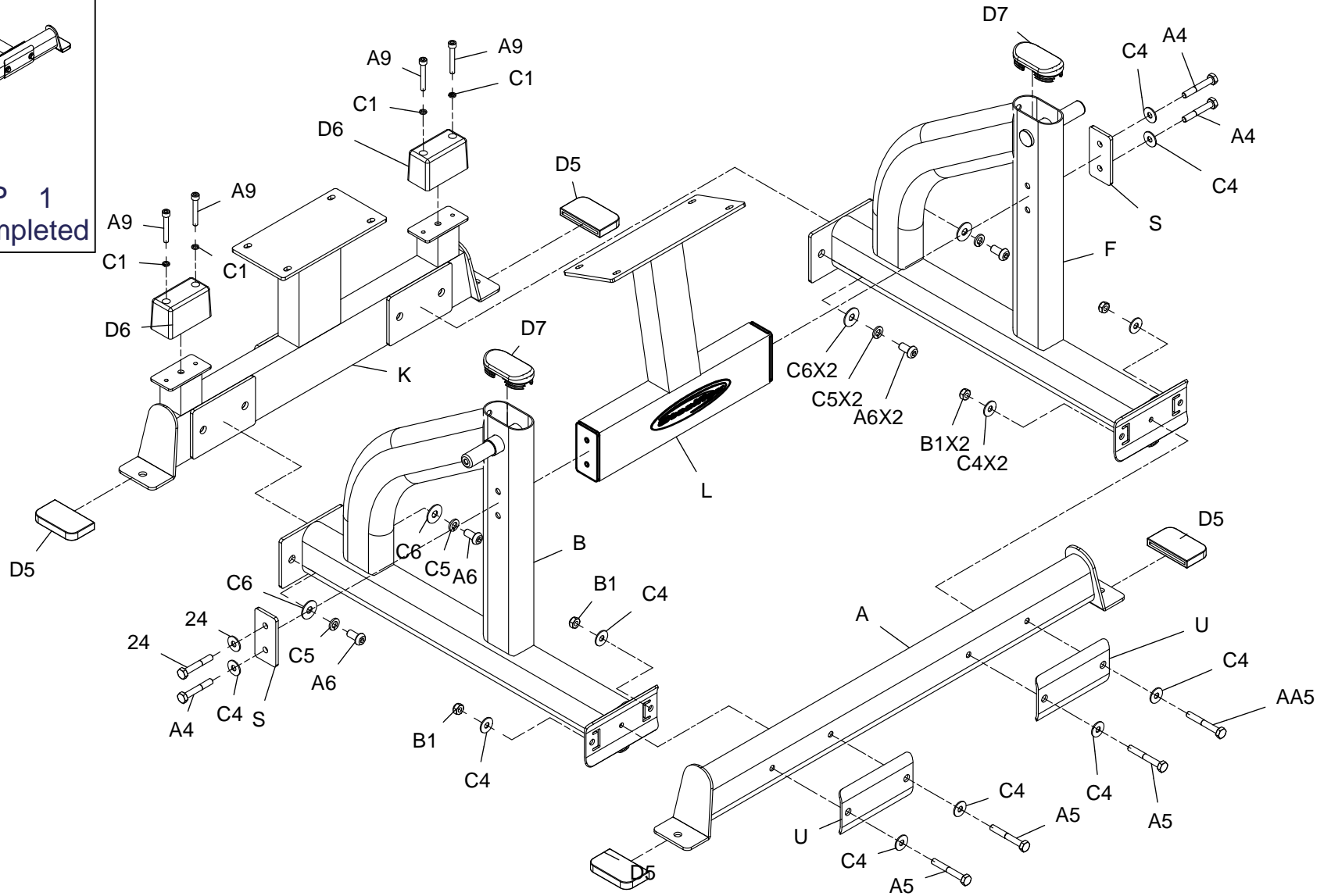



Above shows STEP 1 assembled and completed



KEY

Match the letters inside each triangle

-  connects to 
-  connects to 
-  connects to 

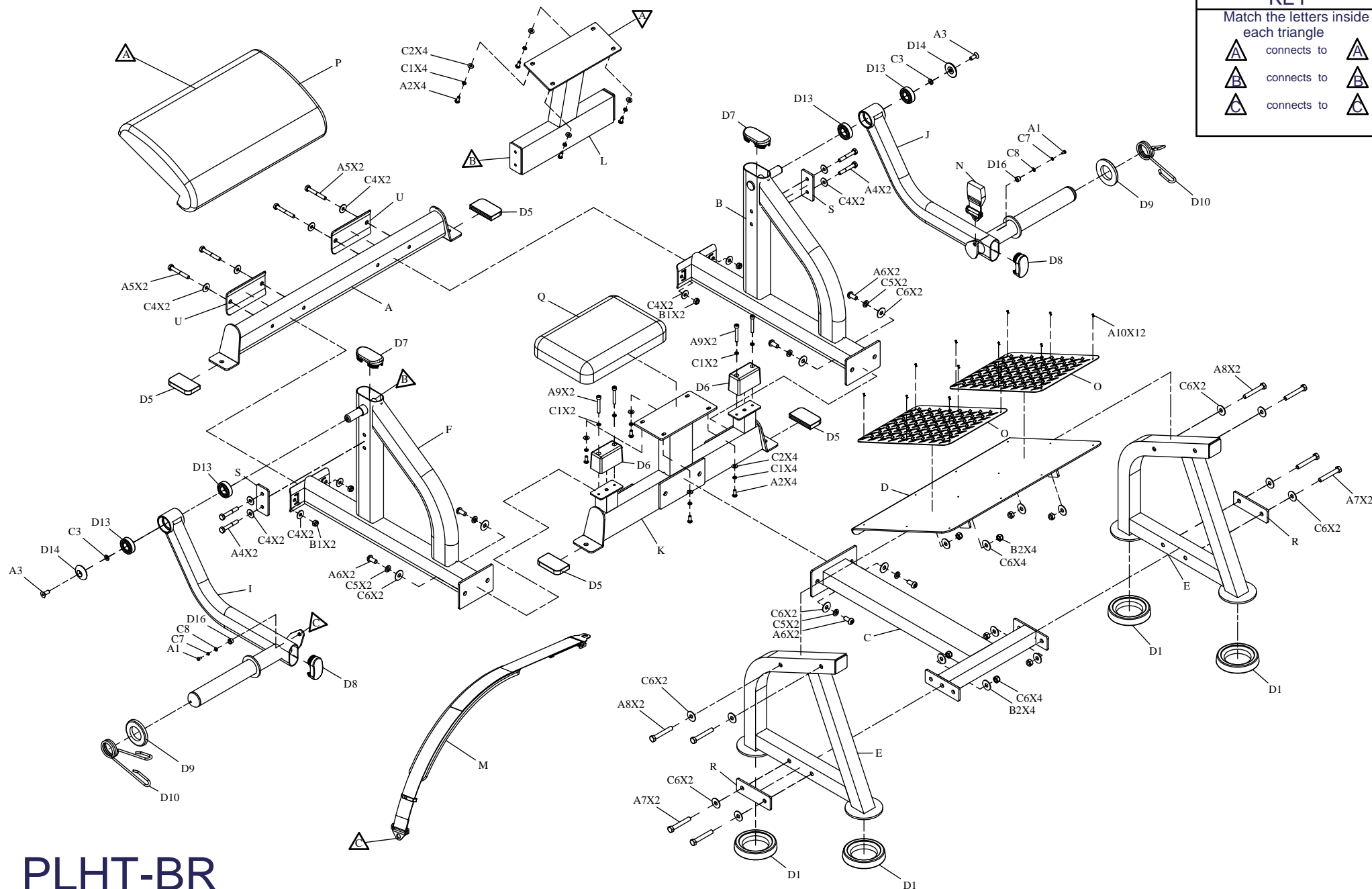

PLHT-BR

Exploded View